

Version	2.0	Date	9/29/17
Prepared By	JC		

PRODUCT SPECIFICATION

Category	Wall Sconce Up/Down
Item Number	7069
Stock Code	LED-FXDWS10/850/WH
Mounting	Wall
Housing Color	White



ELECTRICAL CHARACTERISTICS			
Rated Wattage (W)	10	Replacement Wattage (W)	90
Tested Wattage (W)	10		
Input Voltage (V)	120V	Surge Protect Level	-
Voltage Frequency (Hz)	50/60	Dimmable	-
Input Current (A)	0.1	AUX (12V) Line	-
Power Factor	>0.9		
THD	<20%		

PHOTOMETRIC CHARACTERISTICS			
Lumen (lm)	700	CCT (K)	5000K
Efficacy (lm/w)	-	Beam Angle (°)	38°
CRI	>80		

GENERAL CHARACTERISTICS	
Operating Temperature (°F)	-4°F ~ 104°
Storage Temperature (°F)	-4°F ~ 122°
IP Rating	Wet Location
IK Rating	-
Rated Life (Hrs)	50,000
Warranty (Yrs)	5

ACCESSORIES		
Item #	Stock Code	Description

PRODUCT DIMENSIONS

Width- in / (mm)	5" / 127
Height- in / (mm)	6.70" / 170
Depth- in / (mm)	3.15" / 80
EPA (ft²)	-
Weight (lbs)	1.54
Mounting Height (ft)	-
Cable Length (ft)	-

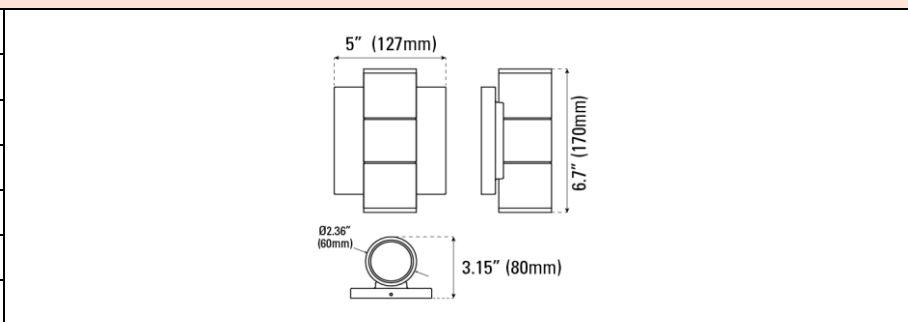

CERTIFICATIONS			
UL/ETL	ETL	CEC	
NSF/ETL Sanitation		JA8	
Energy Star	✓	FCC	
DLC		RoHs	

DOCUMENTS			
LM79	✓	IES File	✓
LM80	✓	Dimmer List	

COMMENTS

--